



# **cabrio<sup>®</sup>**

FABRIC CARE SYSTEM

## TOP-LOADING HIGH EFFICIENCY LOW-WATER WASHER USE AND CARE GUIDE

---

### Table of Contents

WASHER SAFETY .....	2
WASHER DISPOSAL .....	3
WHAT'S NEW UNDER THE LID? .....	4
CONTROL PANEL AND FEATURES .....	5
CYCLE GUIDE .....	7
USING YOUR WASHER .....	8
Using Laundry Product Dispensers .....	9
Starting Your Washer .....	9
WASHER MAINTENANCE .....	11
TROUBLESHOOTING .....	13
ASSISTANCE OR SERVICE .....	17



Designed to use only HE High Efficiency detergents.

# WASHER SAFETY

## Your safety and the safety of others are very important.

We have provided many important safety messages in this manual and on your appliance. Always read and obey all safety messages.



This is the safety alert symbol.

This symbol alerts you to potential hazards that can kill or hurt you and others.

All safety messages will follow the safety alert symbol and either the word "DANGER" or "WARNING." These words mean:

**! DANGER**

**You can be killed or seriously injured if you don't immediately follow instructions.**

**! WARNING**

**You can be killed or seriously injured if you don't follow instructions.**

All safety messages will tell you what the potential hazard is, tell you how to reduce the chance of injury, and tell you what can happen if the instructions are not followed.

## IMPORTANT SAFETY INSTRUCTIONS

**WARNING:** To reduce the risk of fire, electric shock, or injury to persons when using the washer, follow basic precautions, including the following:

- Read all instructions before using the washer. 
- Do not wash articles that have been previously cleaned in, washed in, soaked in, or spotted with petrol, dry-cleaning solvents, other flammable or explosive substances as they give off vapours that could ignite or explode.
- Do not add petrol, dry-cleaning solvents, or other flammable, or explosive substance to the wash water. These substances give off vapours that could ignite or explode.
- Under certain conditions, hydrogen gas may be produced in a hot water system that has not been used for 2 weeks or more. **HYDROGEN GAS IS EXPLOSIVE.** If the hot water system has not been used for such a period, before using the washing machine, turn on all hot water taps and let the water flow from each for several minutes. This will release any accumulated hydrogen gas. As the gas is flammable, do not smoke or use open flame during this time.
- Do not allow children to play on or in the washer. Close supervision of children is necessary when the washer is used near children.
- This appliance is not intended for use by persons (including children) with reduced physical, sensory or mental capabilities, or lack of experience and knowledge, unless they have been given supervision or instructions concerning use of the appliance by persons responsible for their safety.
- Before the washer is removed from service or discarded, remove the door or lid.
- Do not reach into the washer if the drum, tub or agitator is moving.
- Do not install or store the washer where it will be exposed to the weather.
- Do not tamper with controls.
- Do not repair or replace any part of the washer or attempt any servicing unless specifically recommended in this Use and Care Guide/Installation Instruction.
- See Installation Instructions for earthing requirements.
- If the supply cord is damaged, it must be replaced by the manufacturer or its service agent or a similarly qualified person in order to avoid a hazard.

**SAVE THESE INSTRUCTIONS**

## WASHER DISPOSAL



This appliance is marked according to the European directive 2002/ 96/ EC on Waste Electrical and Electronic Equipment (WEEE).

By ensuring this product is disposed of correctly, you will help avoid potential negative consequences for the environment and human health, which could otherwise be caused by inappropriate waste handling of this product.

The symbol on the product, or on the documents accompanying the product, indicates that this appliance may not be treated as household waste. Instead it shall be handed over to the applicable collection point for the recycling of electrical and electronic equipment.

Disposal must be carried out in accordance with local environmental regulations for waste disposal.

For more detailed information about treatment, recovery and recycling of this product, please contact your local city office, your household waste disposal service or the shop where you purchased the product.

# WHAT'S NEW UNDER THE LID?

## Cleaning with Less Water

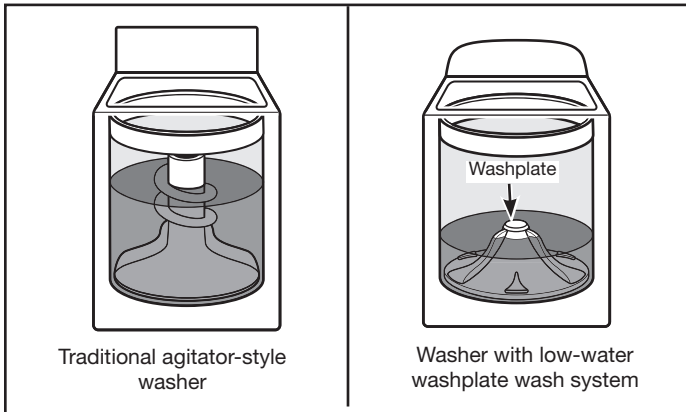

The most striking difference in your new washer is the low-water washplate wash system. The washer automatically adjusts the water level to the load size—no water level selector is needed.



When loading the washer with dirty laundry, fill it evenly around the basket wall.

### Automatic Load Size Sensing

Once you start the cycle, the lid will lock, and the washer will begin the sensing process to determine the correct water level for the load. This may take several minutes. You will find a step-by-step description in the "Cycle Status Lights" section.

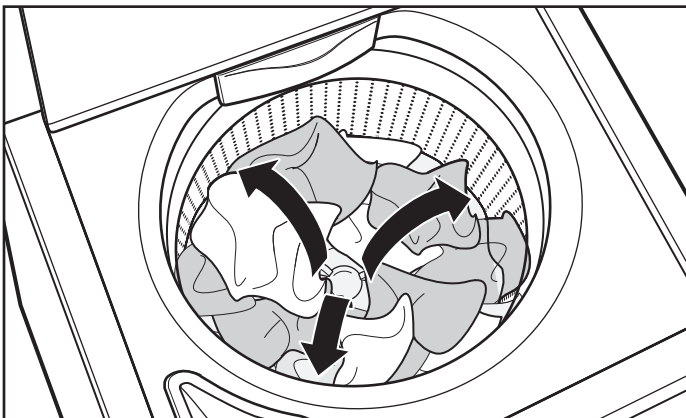

The washplate moves the load while water is added in small amounts until the load is wet. This low-water wash method uses less water and energy compared to a traditional agitator-style washer.



As the washer dampens and moves the load, the level of the clothes will settle in the basket. This is normal, and does not indicate that more clothes should be added.

**IMPORTANT:** You will not see a washer basket full of water like with your past agitator-style washer.

## Choosing the Right Detergent

Use only High Efficiency detergents. The package will be marked "HE" or "High Efficiency." Low-water washing creates excessive sudsing with a regular non-HE detergent. Using regular detergent will likely result in longer cycle times and reduced rinsing performance. It may also result in component failures and noticeable mold or mildew. HE detergents are made to produce the right amount of suds for the best performance. Follow the manufacturer's instructions to determine the amount of detergent to use.



*Use only High Efficiency (HE) detergent.*

## Concentrated Cleaning

Low-water cleaning means concentrated cleaning. Rather than diluting detergent as done in an agitator-style washer, this washer delivers the detergent directly to the soils.

## Normal Sounds You Can Expect

At different stages of the wash cycle, you may hear sounds and noises that are different from those of your previous washer. For example, you may hear a clicking and hum at the beginning of the cycle, as the lid lock goes through a self-test. There will be different kinds of humming and whirring sounds as the washplate moves the load. And sometimes, you may hear nothing at all, as the washer determines the correct water level for your load or allows time for clothes to soak.

# CONTROL PANEL AND FEATURES

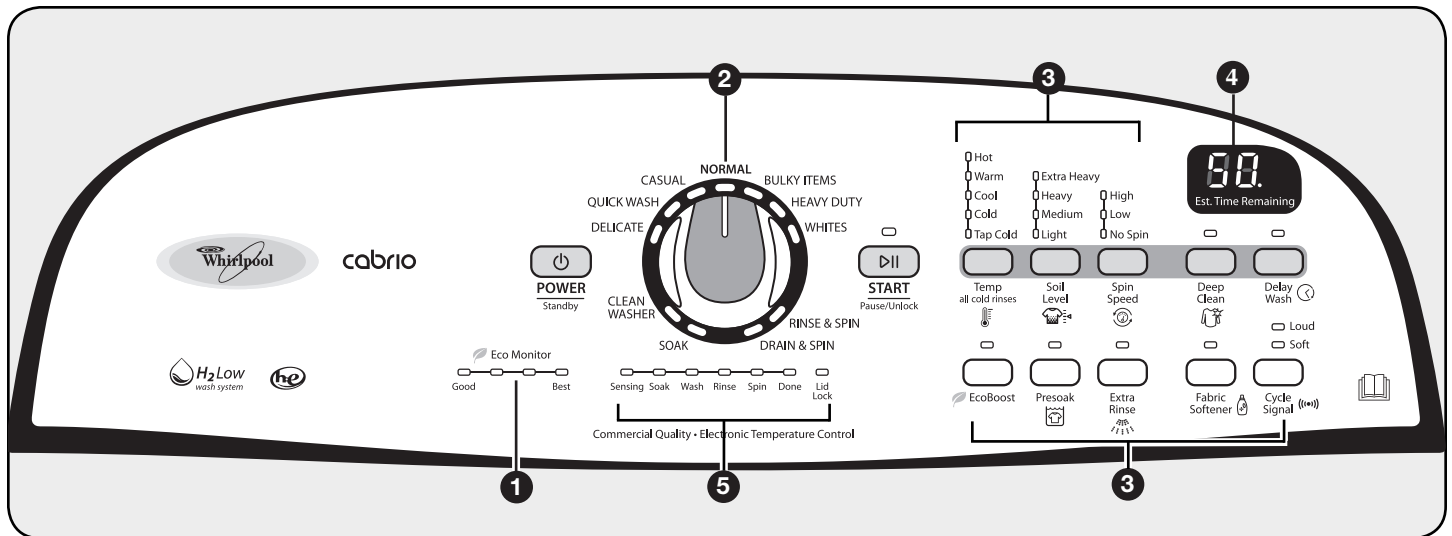

## 1 ECO MONITOR

Your washer is specially designed to conserve energy and water. Each cycle, along with any selected options, will result in different energy usage. As you make your cycle and temperature selections, the Eco Monitor shows how well you are saving energy. Adjust the temperature and spin speed within that cycle to improve energy usage. Using the EcoBoost setting on a cycle can also be a one-touch way to improve your Eco Monitor rating on many cycles.

## 2 WASH CYCLE KNOB

Use the Wash Cycle Knob to select available cycles for your washer. Turn the knob to select a cycle for your laundry load. See "Cycle Guide" for detailed descriptions of cycles.

## 3 CYCLE OPTIONS

When you select a cycle, its default settings will light up.

### TEMP

Temperature Control senses and maintains uniform water temperatures by regulating incoming hot and cold water.

Select a wash temperature based on the type of fabric and soils being washed. For best results and following the garment label instructions, use the warmest wash water safe for your fabric.

- Warm and hot water will be cooler than what your previous washer provided.
- Even in a Cool water wash, some warm water may be added to the washer to maintain a minimum temperature.

### SOIL LEVEL

Soil level (wash time) is preset for each wash cycle. As you press Soil Level, the cycle time (minutes) will increase or decrease in the Estimated Time Remaining display and a different wash time will appear.

For most loads, use the soil level that is preset with the cycle you have chosen. For heavily soiled and sturdy fabrics, press Soil Level to select more wash time, if needed. For lightly soiled and delicate fabrics, press Soil Level to select less wash time, if needed. Lower soil level setting will help reduce tangling and wrinkling.

## SPIN SPEED

This washer automatically selects the spin speed based on the cycle selected. The preset speeds can be changed. Not all spin speeds are available with all cycles.

- Faster spin speeds mean shorter dry times, but may increase wrinkling in your load.
- Slower spin speeds mean less wrinkling, but will leave your load more damp.

You may also add or remove options for each cycle. Note that not all options can be used with all cycles, and some are preset to work with certain cycles.

## DEEP CLEAN/CLEAN BOOST

This option provides enhanced cleaning action for tough stains. It will add additional agitation and soak time to the cycle.

## DELAY WASH

If you would like to set your washer to start at a preferred time, select the Delay Wash option. You can use this option to delay start of a wash cycle for up to 9 hours (depending on model). Press Delay Wash button once to delay 1 hour. If you want a longer delay period, press and hold the button until your desired delay time (in hours) shows in the Estimated Time Remaining display, up to 9H. Then press START/PAUSE/UNLOCK to set the delay. The countdown to the wash cycle will show in the display window.

## ECOBOOST

The EcoBoost option allows you to increase your energy savings on your wash cycles. When this option is used, the wash cycle will use slightly cooler wash water than the selected temperature. The indicated temperature will not change.

## PRESOAK

Use this option to add an extra soak period to any cycle when washing heavily soiled garments. You can adjust the length of the soak period by changing the Soil Level.

## EXTRA RINSE

This option can be used to automatically add a second rinse to most cycles.

## FABRIC SOFTENER

This option must be selected if using fabric softener during a cycle. It ensures that fabric softener is added at the correct time in the rinse for even distribution.

## CYCLE SIGNAL

Use this option to adjust volume of the signal that sounds at end of cycle. You may select Loud, Soft, or Off (no indicator lit). A louder signal is helpful in removing items as soon as cycle is complete.

### To turn button sounds on or off:

Press and hold Cycle Signal for 3 seconds to turn the button sounds off or on.

## 4 EST TIME REMAINING DISPLAY

The Estimated Time Remaining display shows the time required for the cycle to complete. Factors such as load size and water pressure may affect the time shown in the display. Overloading, unbalanced loads, or excessive suds may cause the washer to adjust the cycle time, as well.

## 5 CYCLE STATUS LIGHTS



The Cycle Status Lights shows the progress of a cycle. At each stage of the process, you may notice sounds or pauses that are different from traditional washers.

## SENSING



When the START/Pause/Unlock button is pressed, the washer will first perform a self-test on the lid lock mechanism. You will hear a click, the basket will make a slight turn, and the lid will unlock briefly before locking again.

Once the lid has locked the second time, the washer will slowly spin the dry load to estimate the load size and amount of water needed, and begin adding water. The washer will then move the load briefly, pause to allow water to soak in to the load, and resume adding water. This process may repeat until the correct amount of water has been added for the load. You may also hear water flowing through the dispenser, adding detergent to the load.

**NOTE:** The sensing light may also come on during the Soak and Wash portions of the cycle. This is normal.

## SOAK

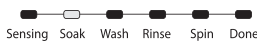

This portion of the cycle allows water to soak into the load for optimal cleaning.

## WASH

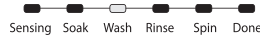

You will hear the washplate moving the load. Unlike traditional washers, the load is not covered with water. Low-water cleaning means concentrated cleaning. Rather than diluting detergent as done in an agitator-style washer, this washer delivers the detergent directly to the soils. The motor sounds may change at different stages in the cycle. The wash time is determined by the selected soil level.

## RINSE



You will hear sounds similar to the wash cycle as the washer rinses and moves the load. Fabric softener will be added if the Fabric Softener option was selected. Some cycles use spray rinsing.

## SPIN



The washer spins the load at increasing speeds for proper water removal, based on the selected cycle and spin speed.

## DONE



Once the cycle is complete, this light will come on. Remove the load promptly for best results.

## LID LOCK



Lid Lock

To allow for proper load sensing and spinning, the lid will lock and the Lid Lock light will turn on. This light indicates that the lid is locked and cannot be opened.

If you need to open the lid, press START/Pause/Unlock. The lid will unlock once the washer movement has stopped. This may take several minutes if the load was spinning at high speed. Press START/Pause/Unlock again to resume the cycle.

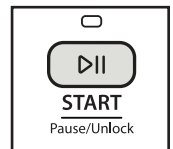

# CYCLE GUIDE

Settings and options shown in **bold** are default settings for that cycle. For best fabric care, choose the cycle that best fits the load being washed.

Not all cycles and options are available on all models. Maximum Load: 8.0 kg

Items to wash:	Cycle:	Wash/Rinse Temperature:	Spin Speed:	Soil Level:	Available Options:	Cycle Details:
Machine-wash silks, hand-wash fabrics	Delicate	Hot/Cold Warm/Cold <b>Cool/Cold</b> Cold/Cold Tap Cold/Cold	High <b>Low</b> No Spin	Extra Heavy Heavy Medium <b>Light</b>	Deep Clean* Extra Rinse Delay Wash EcoBoost Presoak	Use this cycle to wash lightly soiled garments indicating "Machine Washable Silks" or "Gentle" cycle on the care label. Place small items in mesh garment bags before washing. This cycle uses a higher, preset water level.
Small loads, cottons, polyester, perm press	Quick Wash	Hot/Cold <b>Warm/Cold</b> Cool/Cold Cold/Cold Tap Cold/Cold	<b>High</b> Low No Spin	Extra Heavy Heavy Medium <b>Light</b>	Deep Clean* Extra Rinse Delay Wash EcoBoost Presoak	Use this cycle to wash small, lightly soiled loads of 2–3 items that are needed in a hurry. This cycle features a spray rinse.
No-iron fabrics, cottons, perm press, linens, synthetics	Casual	Hot/Cold Warm/Cold <b>Cool/Cold</b> Cold/Cold Tap Cold/Cold	High <b>Low</b> No Spin	Extra Heavy Heavy <b>Medium</b> Light	Deep Clean* Extra Rinse Delay Wash EcoBoost Presoak	Use this cycle to wash loads of no-iron fabrics such as sport shirts, blouses, casual business clothes, permanent press, and blends.
Cottons, linens, and mixed garment loads	Normal†	Hot/Cold <b>Warm/Cold</b> Cool/Cold Cold/Cold Tap Cold/Cold	<b>High</b> No Spin	Extra Heavy Heavy <b>Medium</b> Light	Deep Clean* Extra Rinse Delay Wash EcoBoost Presoak	Use Hot or Warm wash temperature for normally soiled cottons and mixed fabric loads. Cool, Cold, and Tap Cold wash settings allow you to wash smaller, slightly soiled loads. This cycle features a spray rinse. Low-speed spin is not available.
Large items such as sheets, sleeping bags, small comforters, jackets, and small rugs	Bulky Items	Hot/Cold <b>Warm/Cold</b> Cool/Cold Cold/Cold Tap Cold/Cold	High <b>Low</b> No Spin	Extra Heavy Heavy <b>Medium</b> Light	Deep Clean* Extra Rinse Delay Wash EcoBoost Presoak	Use this cycle to wash large items such as jackets and small comforters. The washer will fill with enough water to wet down the load before the wash portion of the cycle begins, and uses a higher water level than other cycles. Do not overload basket.
Sturdy fabrics, colorfast items, towels, jeans	Heavy Duty	<b>Hot/Cold</b> Warm/Cold Cool/Cold Cold/Cold Tap Cold/Cold	<b>High</b> No Spin	<b>Extra Heavy</b> Heavy Medium Light	Deep Clean* Extra Rinse Delay Wash EcoBoost Presoak	Use this cycle for heavily soiled or sturdy items. Water-level sensing process may take longer for some items than for others because they will absorb more water than other fabric types.
Heavily soiled white fabrics	Whites	<b>Hot/Cold</b> Warm/Cold Cool/Cold Cold/Cold Tap Cold/Cold	<b>High</b> Low No Spin	<b>Extra Heavy</b> Heavy Medium Light	<b>Deep Clean*</b> <b>Extra Rinse</b> Delay Wash EcoBoost Presoak	Deep Clean and Extra Rinse are default options, but may be turned off. For maximum soil removal use liquid chlorine bleach.
Swimsuits and items requiring rinsing without detergent	Rinse & Spin	Tap Cold/Cold	<b>High</b> Low No Spin			Combines a rinse and spin for loads requiring an additional rinse cycle or to complete a load after power interruption. Spin speed is selectable; default is high. This cycle uses a higher, preset water level. Also use for loads that require rinsing only.
Hand-washed items or dripping wet items	Drain & Spin		<b>High</b> Low No Spin			This cycle uses a spin to shorten drying times for heavy fabrics or special-care items washed by hand. Use this cycle to drain washer after cancelling a cycle or completing a cycle after a power failure.
Heavily soiled fabrics	Soak	Hot/Cold Warm/Cold <b>Cool/Cold</b> Cold/Cold Tap Cold/Cold	<b>No Spin</b>	Extra Heavy Heavy Medium <b>Light</b>	Delay Wash EcoBoost	Select Soil Level to adjust soaking cycle time. After time has expired, water will drain but washer will not spin. This cycle uses a higher, preset water level.
No clothes in washer	Clean Washer	<b>Hot/Cold</b>	<b>High</b>	<b>Extra Heavy</b>		Use once a month to keep the inside of the washer fresh and clean. Higher water levels and bleach work together to thoroughly clean the washer interior.

\* Or Clean Boost (on some models).

† Reference programme for Energy and Water Labeling, according to Australian Standards AS/NZS 2040.1 and AS/NZS 2040.2, with the following options selected: Normal, Warm Temperature, Extra Heavy Soil Level, High Spin Speed, Deep Clean, and Presoak.

# USING YOUR WASHER

## ⚠ WARNING



### Fire Hazard

Never place items in the washer that are dampened with petrol or other flammable fluids.

No washer can completely remove oil.

Do not dry anything that has ever had any type of oil on it (including cooking oils).

Doing so can result in death, explosion, or fire.

## ⚠ WARNING



### Electric Shock Hazard

Electrically earth this appliance.

Do not use an extension cord or an electrical portable outlet device.

Failure to follow these instructions can result in death, fire, or electric shock.

## 1. Sort and prepare your laundry

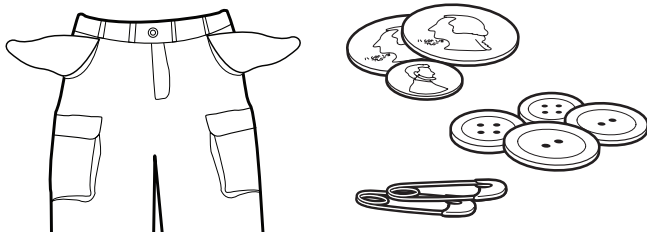

- Empty pockets. Loose change, buttons, or any small object can pass under the washplate and become trapped, causing unexpected sounds.
- Sort items by recommended cycle, water temperature, and colorfastness.
- Separate heavily soiled items from lightly soiled.
- Separate delicate items from sturdy fabrics.
- Do not dry garments if stains remain after washing, because heat can set stains into fabric.
- Treat stains promptly.
- Close zippers, fasten hooks, tie strings and sashes, and remove non-washable trim and ornaments.
- Mend rips and tears to avoid further damage to items during washing.

### Helpful Tips:

- When washing water-proof or water-resistant items, load evenly. See "Cycle Guide" for tips and more information on using the Bulky Items cycle.
- Use mesh garment bags to help avoid tangling when washing delicate or small items.
- Turn knits inside out to avoid pilling. Separate lint-takers from lint-givers. Synthetics, knits, and corduroy fabrics will pick up lint from towels, rugs, and chenille fabrics.

Always read and follow fabric care label instructions to avoid damage to your garments.

## 2. Load laundry into washer

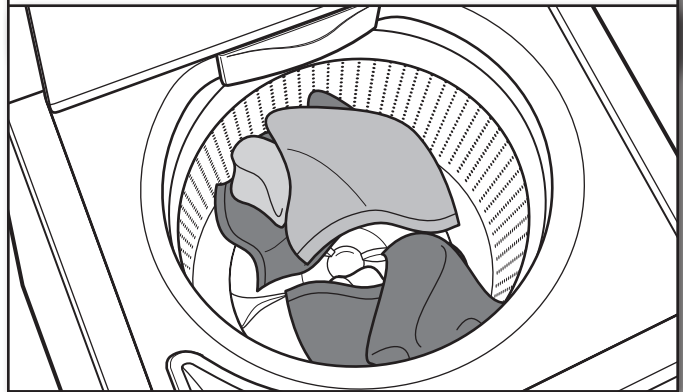

Load garments in loose heaps evenly around basket wall. Do not wrap large items such as sheets around the washplate; load them in loose piles around the sides of the basket. Try mixing different sized items to reduce tangling.

**IMPORTANT:** Items need to move freely for best cleaning and to reduce wrinkling and tangling.



## Using Laundry Product Dispensers

### 3. Add HE detergent to dispenser

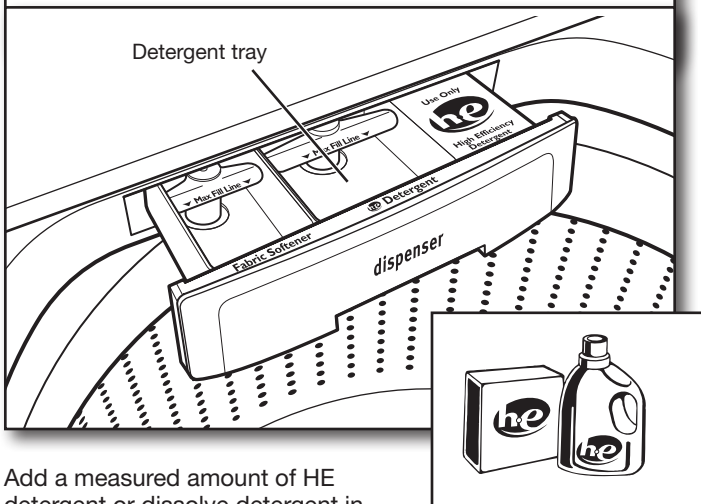

Add a measured amount of HE detergent or dissolve detergent in warm water and pour into detergent tray. This tray holds 89 mL (3 oz.). Do not overfill tray – adding too much detergent may cause detergent to be dispensed into the washer too early.

**IMPORTANT:** Use only High Efficiency detergents. The package will be marked “HE” or “High Efficiency.” Low-water washing creates excessive sudsing with a regular non-HE detergent. Using regular detergent will likely result in longer cycle times and reduced rinsing performance. It may also result in component failures and noticeable mold or mildew. HE detergents are made to produce the right amount of suds for the best performance. Follow the manufacturer’s instructions to determine the amount of detergent to use.

#### Using Oxi or color-safe bleach:

If using an Oxi or color-safe bleach laundry boost product, add to the bottom of the washer basket before adding clothes.

**HELPFUL TIP:** See “Washer Maintenance” for information on recommended method of cleaning washer dispenser trays.

### 4. Add liquid chlorine bleach to dispenser

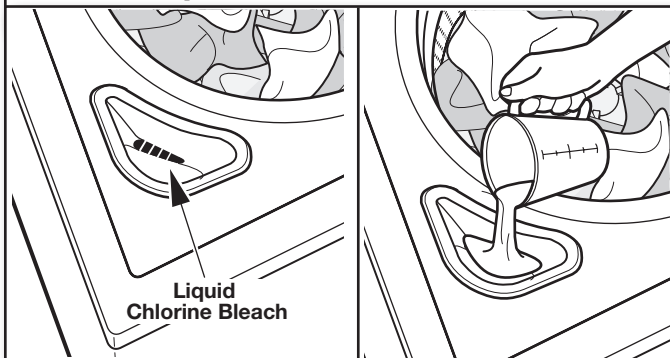

Do not overfill, dilute, or use more than 250 mL (1 cup). Do not use color-safe bleach or Oxi products in the same cycle with liquid chlorine bleach.

### 5. Add fabric softener to dispenser

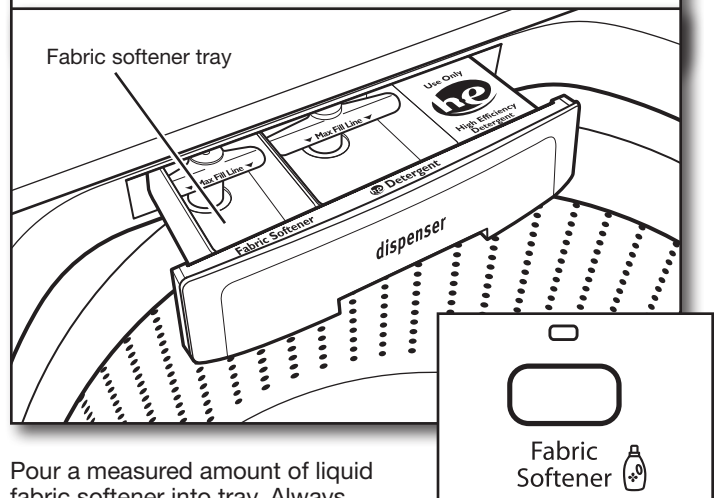

Pour a measured amount of liquid fabric softener into tray. Always follow manufacturer’s directions for correct amount of fabric softener based on your load size. Close dispenser drawer, then select Fabric Softener option.

**IMPORTANT:** Fabric Softener option must be selected to ensure proper distribution at correct time in cycle. Do not overfill or dilute. Overfilling dispenser will cause fabric softener to immediately dispense into washer.

If Extra Rinse option is selected, fabric softener will be dispensed into the last rinse.

It is normal for a small amount of water to remain in the dispenser at the end of a cycle.

## Starting Your Washer

### 6. Press POWER to turn on washer



Make sure the dispenser drawer is closed completely, then press POWER to turn on the washer.

## 7. Select cycle

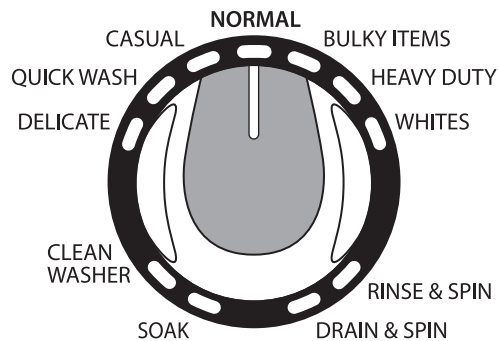

Turn cycle knob to choose your wash cycle. When knob is lined up with a cycle, you will hear a clicking sound. Indicator for Estimated Time Remaining will light up with a cycle time. For more information, see “Control Panel and Features”.

If you do not want to begin a cycle immediately, you may choose DELAY WASH option.

### To set a delayed Start:

1. Press DELAY WASH button to select desired start time.



2. Press START/Pause/Unlock to set the delay. The delay countdown has started when the START/Pause/Unlock light stops blinking.

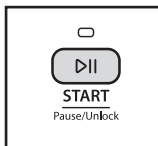

### To cancel delaying a cycle:

Press START/Pause/Unlock again to begin a wash cycle immediately.

**IMPORTANT:** When delaying a cycle, use liquid HE detergent only in the detergent dispenser tray. Powdered detergents may absorb moisture from a previous cycle and clump before the wash cycle begins.



## 8. Select cycle settings

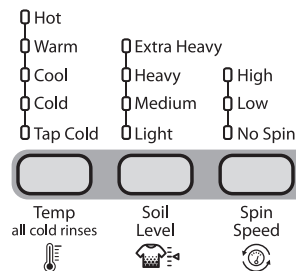

Once you select a cycle, the default settings for that cycle will be lit. Press the cycle settings buttons to change the Temperature, Soil Level, and Spin Speed, if desired.

**NOTE:** Always read and follow fabric care label instructions to avoid damage to your garments.

Wash Temp	Suggested Fabrics
<b>Hot</b> Some cold water is added to save energy. This will be cooler than your hot water heater setting.	Whites and pastels Durable garments Heavy soils
<b>Warm</b> Some cold water will be added, so this will be cooler than what your previous washer provided.	Bright colors Moderate to light soils
<b>Cool – brights/darks</b> Warm water is added to assist in soil removal and to help dissolve detergents.	Colors that bleed or fade Light soils
<b>Cold</b> Warm water may be added to assist in soil removal and to help dissolve detergents.	Dark colors that bleed or fade Light soils
<b>Tap Cold</b> This is the temperature from your tap.	Dark colors that bleed or fade Light soils

## 9. Select cycle options

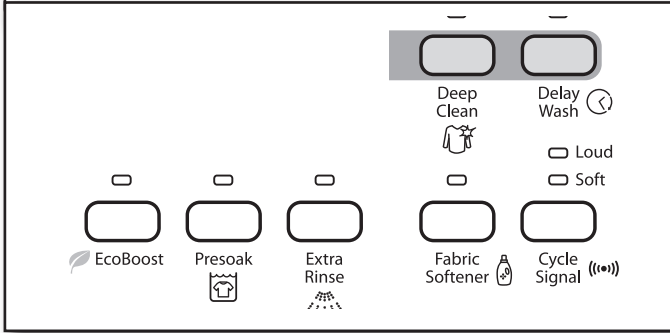

Select any other cycle options you may wish to add, if not previously set. Some cycles will automatically add certain options such as Deep Clean or Extra Rinse. These can be turned off, if desired.

**NOTE:** Not all options are available with all cycles.

## 10. Press START/Pause/Unlock to begin wash cycle



Press the START/Pause/Unlock button to start the wash cycle. When the cycle has finished, the DONE indicator will light and the end of cycle signal will sound (if set). Promptly remove garments after cycle has completed to avoid odor, reduce wrinkling, and rusting of metal hooks, zippers, and snaps.

### Unlocking the lid to add garments:

If you need to open the lid to add 1 or 2 missed garments:

Press START/Pause/Unlock; the lid will unlock once the washer movement has stopped. This may take several minutes if the load was spinning at high speed. Then close lid and press START/Pause/Unlock again to restart the cycle.

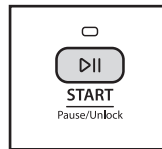

If lid is left open for more than 10 minutes the water will pump out automatically.

## WASHER MAINTENANCE

### WATER INLET HOSES

Replace inlet hoses after 5 years of use to reduce the risk of hose failure. Periodically inspect and replace inlet hoses if bulges, kinks, cuts, wear, or leaks are found.

When replacing your inlet hoses, mark the date of replacement on the label with a permanent marker.

### CLEANING YOUR WASHER

Keep your washer as clean and fresh as your clothes. To keep washer interior odor-free, follow this recommended monthly cleaning procedure:

1. Make sure the washer is empty.
2. If using liquid chlorine bleach, add 1 cup (250 mL) to liquid chlorine bleach dispenser.

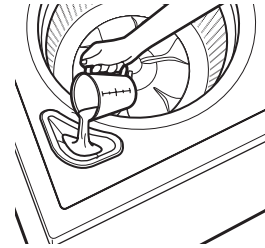

**IMPORTANT:** Do not add detergent to CLEAN WASHER cycle. Do not use more than recommended amount of bleach to avoid damaging product over time.

3. Close washer lid.
4. Press POWER.
5. Select CLEAN WASHER cycle.
6. Press START/Pause/Unlock. Water will pour into washer for a moment and pause, lid will lock, then cycle will continue.

**NOTE:** For best results, do not interrupt cycle. If cycle must be interrupted, press POWER and run a RINSE AND SPIN cycle to ensure cleaner or bleach have been rinsed from washer.

### To clean exterior:

1. Use a soft, damp cloth or sponge to wipe up any spills.
2. Use all-purpose surface cleaner, if needed.

**IMPORTANT:** To avoid damaging the washer's finish, do not use abrasive products.

## CLEANING YOUR DISPENSER TRAY

You may find laundry product residue leftover in your dispenser trays. To remove residue, follow this recommended cleaning procedure:

1. Pull tray out until you feel resistance.
2. Lift up slightly, and then continue pulling out.
3. Wash in warm, soapy water, using a mild detergent.
4. Rinse with warm water.
5. Air dry, or dry with a towel, then place back into slot.

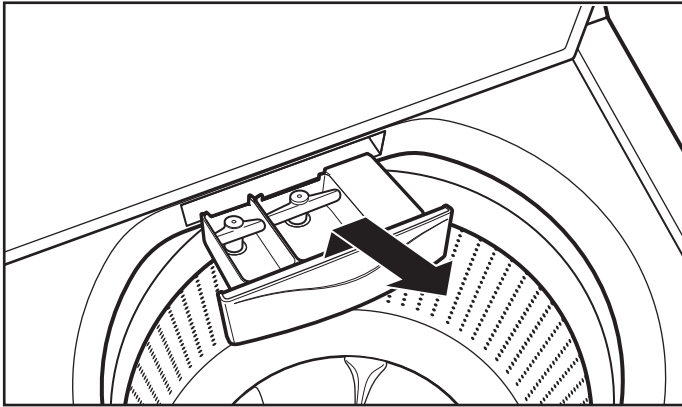

**IMPORTANT:** Dispenser trays are not dishwasher safe.

## NON-USE AND VACATION CARE

Operate your washer only when you are home. If moving, or not using your washer for a period of time, follow these steps:

1. Unplug or disconnect power to washer.
2. Turn off water supply to washer, to avoid flooding due to water pressure surge.

## WINTER STORAGE CARE

**IMPORTANT:** To avoid damage, install and store washer where it will not freeze. Because some water may stay in hoses, freezing can damage washer. If storing or moving during freezing weather, winterize your washer.

### To winterize washer:

1. Shut off both water taps, disconnect and drain water inlet hoses.
2. Put 1 qt. (1 L) of R.V.-type antifreeze in basket and run washer on RINSE AND SPIN cycle for about 30 seconds to mix antifreeze and remaining water.
3. Unplug washer or disconnect power.

## TRANSPORTING YOUR WASHER

1. Shut off both water taps. Disconnect and drain water inlet hoses.
2. If washer will be moved during freezing weather, follow "Winter Storage Care" directions before moving.
3. Disconnect drain from drain system and drain any remaining water into a pan or bucket. Disconnect drain hose from back of washer.
4. Unplug power cord.
5. Place inlet hoses and drain hose inside washer basket.
6. Drape power cord over edge and into washer basket.
7. Place packing tray from original shipping materials back inside washer. If you do not have packing tray, place heavy blankets or towels into basket opening. Close lid and place tape over lid and down front of washer. Keep lid taped until washer is placed in new location.

## ⚠ WARNING



### Electric Shock Hazard

Electrically earth this appliance.

**Do not use an extension cord or an electrical portable outlet device.**

**Failure to follow these instructions can result in death, fire, or electric shock.**

## REINSTALLING/USING WASHER AGAIN

To reinstall washer after non-use, vacation, winter storage or moving:

1. Refer to "Installation Instructions" to locate, level, and connect washer.
2. Before using again, run washer through the following recommended procedure:

### To use washer again:

1. Flush water pipes and hoses. Reconnect water inlet hoses. Turn on both water taps.
2. Plug in washer or reconnect power.
3. Run washer through BULKY ITEMS cycle to clean washer and remove antifreeze, if used. Use only HE High Efficiency detergent. Use half the manufacturer's recommended amount for a medium-size load.

# TROUBLESHOOTING

First try the solutions suggested here for assistance and to possibly avoid a service call.

If you experience	Possible Causes	Solution
<b>Vibration or Off-Balance</b>		
Check the following for proper installation or see "Using Your Washer" section.	Feet may not be in contact with the floor and locked.	Front and rear feet must be in firm contact with floor, and washer must be level to operate properly. Jam nuts must be tight against the bottom of the cabinet.
	Washer may not be level.	Check floor for flexing or sagging. If flooring is uneven, a 19 mm (3/4") piece of plywood under your washer will reduce sound. See "Level the Washer" in "Installation Instructions."
	Load could be unbalanced.	Load dry items in loose heaps evenly around basket wall. Adding wet items to washer or adding more water to basket could unbalance washer.
		Wash smaller loads to reduce imbalance.
		Use Bulky Items cycle for oversized, non-absorbent items such as comforters or poly-filled jackets.
		See "Cycle Guide" and "Using Your Washer" in this "Use and Care Guide."
<b>Noises</b>		
Clicking or metallic noises	Objects caught in washer drain system.	Empty pockets before washing. Loose items such as coins could fall between basket and tub or may block pump. It may be necessary to call for service to remove items. It is normal to hear metal items on clothing such as metal snaps, buckles, or zippers touch against the stainless steel basket.
Gurgling or humming	Washer may be draining water.	It is normal to hear the pump making a continuous humming sound with periodic gurgling or surging as final amounts of water are removed during the spin/drain cycles.
<b>Water Leaks</b>		
Check the following for proper installation:	Washer not level.	Water may splash off basket if washer is not level.
	Fill hoses not attached tightly.	Tighten fill-hose connection.
	Fill hose washers.	Make sure all four fill hose flat washers are properly seated.
	Drain hose connection.	Pull drain hose from washer cabinet and properly secure it to drainpipe or laundry tub.
	Check household plumbing for leaks or clogged sink or drain.	Water can backup out of a clogged sink or drainpipe. Check all household plumbing for leaks (laundry tubs, drain pipe, water pipes, and taps.)
	Washer not loaded properly.	Unbalanced loading can cause basket to be out of alignment and cause water to splash off tub. See "Using Your Washer" for loading instructions.
<b>Washer not performing as expected</b>		
Not enough water in washer	Load not completely covered in water.	This is normal operation for an HE low-water washer. The load will not be completely underwater. The washer senses load sizes and adds correct amount of water for optimal cleaning. See "What's New under the Lid." <b>IMPORTANT:</b> Do not add more water to washer. The added water lifts the load off the washplate, resulting in less cleaning.

# TROUBLESHOOTING

## ⚠ WARNING



### Electric Shock Hazard

Electrically earth this appliance.

Do not use an extension cord or an electrical portable outlet device.

Failure to follow these instructions can result in death, fire, or electric shock.

First try the solutions suggested here for assistance and to possibly avoid a service call.

If you experience	Possible Causes	Solution
<b>Washer not performing as expected (cont.)</b>		
Washer won't run or fill, washer stops working	Check for proper water supply.	Both hoses must be attached and have water flowing to inlet valve.
		Both Hot and Cold water taps must be turned on.
		Check that inlet valve screens have not become clogged.
		Check for any kinks in inlet hoses, which can restrict water flow.
	Check proper electrical supply.	Do not use an extension cord.
		Ensure there is power to outlet.
		Reset a tripped circuit breaker. Replace any blown fuses. <b>NOTE:</b> If problems continue, contact an electrician.
	Normal washer operation.	Lid must be closed for washer to run.
		Washer will pause during certain phases of cycle. Do not interrupt cycle.
		Washer may be stopped to reduce suds.
		Washer spins the load before filling to determine load size.
	Washer not loaded properly.	Remove several items, rearrange load evenly in basket and add detergent. Close lid and press START/Pause/Unlock.
		Do not add more than 1 or 2 additional items after cycle has started.
		Do not add more water to the washer.
	Not using HE detergent or using too much HE detergent.	Only use HE detergent. Suds from regular detergents can slow or stop the washer. Always measure detergent and follow detergent directions based on your load requirements.
		To remove suds, cancel cycle. Select RINSE & SPIN. Press START/Pause/Unlock. Do not add more detergent.

# TROUBLESHOOTING

First try the solutions suggested here for assistance and to possibly avoid a service call.

If you experience	Possible causes	Solution
<b>Washer not performing as expected (cont.)</b>		
Washer not draining/spinning, loads are still wet	Empty pockets and use garment bags for small items.	Small items may have been caught in pump or between basket and tub, which can slow draining.
	Using a cycle with a low spin speed.	Cycles with lower spin speeds remove less water than cycles with high spin speeds. Use the recommended cycle/speed spin for your garment. To remove extra water in the load, Select Drain & Spin. Load may need to be rearranged to allow even distribution of the load in the basket.
	Washer not loaded properly.	Reduce load size to improve water removal. A tightly packed load may not allow the washer from spinning correctly, leaving the load wetter than normal.
	Check plumbing for correct drain hose installation. Drain hose extends into standpipe farther than 114 mm (4.5").	Check drain hose for proper installation. Use drain hose form and securely attach to drainpipe or tub. Do not tape over drain opening. Lower drain hose if the end is higher than 2.4 m (96") above the floor. Remove any clogs from drain hose.
	Wrong or too much detergent causing suds to slow or stop draining and spinning.	Use only HE detergent. Always measure and follow detergent directions for your load. To remove extra suds, select RINSE & SPIN. Do not add detergent.
Dry spots on load after cycle	High-speed spins extract more moisture than traditional top-load washers.	The high spin speeds combined with air flow during the final spin can cause items near the top of the load to develop dry spots during the final spin. This is normal.
Incorrect or wrong wash or rinse temperatures	Check for proper water supply.	Make sure hot and cold inlet hoses are not reversed.
		Both hoses must be attached to both washer and tap, and have both hot and cold water flowing to inlet valve.
Check that inlet valve screens are not clogged.		
Remove any kinks in hoses.		
Energy-saving controlled wash temperatures.	This washer uses cooler wash and rinse water temperatures than your previous washer. This includes cooler hot and warm washes.	
Load not rinsed	Check for proper water supply.	Make sure hot and cold inlet hoses are not reversed.
		Both hoses must be attached and have water flowing to the inlet valve.
		Both hot and cold water taps must be on.
		Inlet valve screens on washer may be clogged.
		Remove any kinks in the inlet hose.
	Not using HE detergent or using too much HE detergent.	The suds from regular detergent can keep washer from operating correctly.
		Use only HE detergent. Be sure to measure correctly.
		Always measure detergent and follow detergent directions based on load size and soil level.
	Washer not loaded as recommended.	The washer is less efficient at rinsing when the load is tightly packed.
		Load garments in loose heaps evenly around the basket wall. Load with dry items only.
Use cycle designed for the fabrics being washed.		
Add only 1 or 2 garments after washer has started.		

# TROUBLESHOOTING

First try the solutions suggested here for assistance and to possibly avoid a service call.

If you experience	Possible Causes	Solution
<b>Washer not performing as expected (cont.)</b>		
Sand, pet hair, lint, etc. on load after washing	Heavy sand, pet hair, lint, and detergent or bleach residues may require additional rinsing.	Add an Extra Rinse to the selected cycle.
Load is tangling	Washer not loaded as recommended.	See “Using Your Washer” section.
		Select a cycle with a slower wash action and spin speed; however items will be wetter than those using a higher speed spin.
		Load garments in loose heaps evenly around the basket wall.
		Reduce tangling by mixing types of load items. Use the recommended cycle for the type of garments being washed.
Not cleaning or removing stains	Wash load not completely covered in water.	Washer senses load size and adds correct amount of water. This is normal and necessary for clothes to move.
	Added more water to washer.	Added water lifts the laundry off the washplate, resulting in less effective cleaning.
	Washer not loaded properly.	Washer is less efficient at cleaning when load is tightly packed.
		Load garments in loose heaps evenly around the basket wall. Load with dry items only.
		Add only 1 or 2 garments after washer has started.
	Not using HE detergent or using too much HE detergent.	The suds from regular detergent can keep washer from operating correctly.
		Use only HE detergent. Be sure to measure correctly.
		Always measure detergent and follow manufacturer’s directions based on load size and soil level.
	Not using correct cycle for fabric type.	Use a higher soil level cycle option and warmer wash temperature to improve cleaning.
		If using Quick Wash cycle, wash only a few items.
		Use Whites and Heavy Duty cycle for tough cleaning.
	Not using dispensers.	Use dispensers to avoid chlorine bleach and fabric softener staining.
		Load dispensers before starting a cycle.
Avoid overfilling.		
Do not add products directly to load.		
Not washing like colors together.	Wash like colors together and remove promptly after the cycle is complete to avoid dye transfer.	
Small amount of water still in dispenser after cycle	Normal dispenser operation.	It is normal for small amounts of water to remain in dispenser.

# TROUBLESHOOTING

First try the solutions suggested here for assistance and to possibly avoid a service call.

If you experience	Possible Causes	Solution
<b>Washer not performing as expected (cont.)</b>		
Incorrect dispenser operation	Clogged dispensers or laundry products dispensing too soon.	Do not overfill dispenser, which causes immediate dispensing.
		Always select Fabric Softener option to ensure proper dispensing.
		Load dispensers before starting a cycle.
		Homes with low water pressure may result in residual powder in the dispenser. To avoid, select a warmer wash temperature if possible, depending on your load, or use liquid HE detergent.
	Use only liquid chlorine bleach in the bleach dispenser.	
	Residual powder in dispenser.	In wash water temperatures colder than 15.6° C (60° F), some detergents do not dissolve well. Soils may be difficult to remove. To avoid, select a warmer wash temperature if possible, depending on your load, or use liquid HE detergent.
Fabric damage	Sharp items were in pockets during wash cycle.	Empty pockets, zip zippers, and snap or hook fasteners before washing to avoid snags and tears.
	Strings and straps could have tangled.	Tie all strings and straps before starting wash load.
	Items may have been damaged before washing.	Mend rips and broken threads in seams before washing.
	Fabric damage can occur in a tightly packed load.	Load garments in loose heaps evenly around the basket wall. Load with dry items only.
		Use cycle designed for the fabrics being washed.
		Add only 1 or 2 garments after washer is started.
	Liquid chlorine bleach may have been added incorrectly.	Do not pour liquid chlorine bleach directly onto load. Wipe up bleach spills.
		Undiluted bleach will damage fabrics. Do not use more than recommended by manufacturer.
Do not place load items on top of bleach dispenser when loading and unloading washer.		
	Garment care instructions may not have been followed.	Always read and follow garment manufacturer's care label instructions.
No sound when buttons are pressed	Button sounds are turned off.	Button sounds can be turned on or off by pressing and holding Cycle Signal for 5 seconds.
Odors	Monthly maintenance not done as recommended.	Run the Clean Washer cycle monthly. See "Cleaning Your Washer" in "Washer Maintenance."
		Unload washer as soon as cycle is complete.
	Using wrong or too much detergent.	Use only HE detergent. Be sure to measure correctly.
		Always follow the manufacturer's directions.
		See "Cleaning your Washer" section.
Estimated Time Remaining is not correct	Excess suds caused by not using HE detergent or using too much detergent.	If excess suds are detected, the washer will add extra rinsing and pauses to break down suds. This will lengthen the cycle time. Use only HE detergent. Be sure to measure correctly.

## ASSISTANCE OR SERVICE

Before calling for assistance or service, please check "Troubleshooting." It may save you the cost of a service call. If you still need help, contact the dealer from whom you purchased the washer, or a Whirlpool designated service company.

When calling, please know the purchase date and the complete model and serial number of your appliance. This information will help us to better respond to your request.

# NOTES

# NOTES

**W10354485B**

© 2011 Whirlpool Corporation.  
All rights reserved.

® Registered Trademark/TM Trademark of Whirlpool, U.S.A.

02/11  
Printed in U.S.A.